

XSP High Output Series

XSP1™ High Output LED Street/Area Luminaire - Single Module

Product Description

Designed from the ground up as a totally optimized LED street and area lighting system, the XSP High Output Series delivers incredible efficiency without sacrificing application performance. Beyond substantial energy savings and reduced maintenance, Cree achieves greater optical control with our NanoOptic® Precision Delivery Grid™ optic when compared to traditional cobra head luminaires. The XSP High Output Series is the better alternative for traditional street and area lighting with quick payback and improved performance.

Applications: Roadway, parking lots, walkways and general area spaces.

Performance Summary

NanoOptic® Precision Delivery Grid™ optic

CRI: Minimum 70 CRI

CCT: 3000K (+/- 300K), 4000K (+/- 300K); 5700K (+/- 500K)

Limited Warranty†: Class 1 – 10 years on luminaire / 10 years on Colorfast DeltaGuard® finish
Class 2 – 5 years on luminaire / 10 years on Colorfast DeltaGuard® finish

Accessories

Field-Installed	
KIT-XSP-AP60-48-G0 Fitter kit to mount to 48mm tenon	KIT-XSP-AP60-42-G0 Fitter kit to mount to 42mm tenon
KIT-XSP-AP60-34-G0 Fitter kit to mount to 34mm tenon	

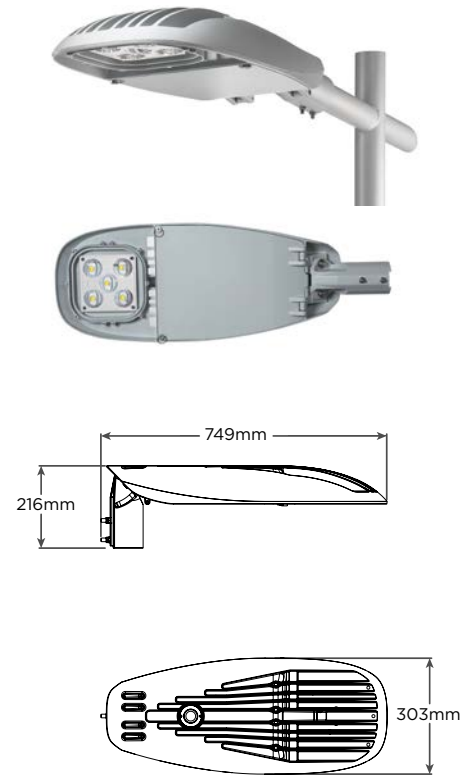

Ordering Information										
Example: XSPD022LGE30K+24SVQ901										
XSP	D	02	2LG	E	30K	+	24	SV	Q9	01
Product	Version	Mounting	Optic	Input Power Designator	CCT	Insulation Class	Voltage	Color Options	Options	Cable length**
XSP	D	02 horiz/vert tenon 60mm OD	2LG Type II Long 275 Type II Short 0.75 210	E 98W H 67W	30K 3000K 40K 4000K 57K 5700K	+	24 220-240V	SV Silver BK Black BZ Bronze SB Silver WH White	No code Fixed Output Available with Input Power E: Q# Field Adjustable Output - Requires no additional wiring Y# - Z# Virtual Midnight - Field programmable NEM* NQ#* NY#* NZ#* Available with Input Power H: G# L# DL CLO DY# DCL NDL* NCL* NDC*	No code Standard (w/o cable) 01 Exit cable 30cm 03 Exit cable 3m 06 Exit cable 6m 10 Exit cable 10m 12 Exit cable 12m

* available only in Class 1
** w/o connector

XSP1™ High Output LED Street/Area Luminaire - Single Module

Product Specifications

CONSTRUCTION & MATERIALS

- Die cast aluminum housing
- Tool-less entry
- Luminaire is designed to mount directly to 76mm or 60mm outer dimension tenons or poles and can be tilted +/- 20°, in steps of 5°
- Luminaire fitter 02 can mount to 60mm OD tenons and fitter 03 to 76mm
- Luminaire will also mount to 34-42-48mm outer dimension tenon or pole with an accessory fitter kit
- Exclusive Colorfast DeltaGuard® finish features an E-Coat epoxy primer with an ultra-durable powder topcoat, providing excellent resistance to corrosion, ultraviolet degradation and abrasion. Standard is Silver. Black, Bronze, Silver Bronze and White are also available

ELECTRICAL SYSTEM

- **Input Voltage:** 220-240V, 50/60Hz
- **Power Factor:** > 0.95 at full load
- **Total Harmonic Distortion:** < 10% at full load
- Surge suppression protection standard up to integral 10kV
- To address inrush current, slow blow fuse or type B/C breaker should be used

REGULATORY & VOLUNTARY QUALIFICATIONS

- CE Listed
- ENEC Listed
- RoHs compliant
- Risk group exempt in accordance with Standard CEI EN 62471 for photobiological safety
- Enclosure rated IP66 per IEC 60529
- Impact resistance IK08
- 10kV surge suppression protection tested in accordance with EN 61000-4-5
- Luminaire and finish endurance tested to withstand 5,000 hours of elevated ambient salt fog conditions as defined in ASTM Standard B 117

Electrical Data*			
Input Power Designator	System Watts 220-240V	Total Current	Power Factor
		230V	
E	98	0.44	0.96
H	67	0.30	0.99

* Electrical data at 25°C (77°F)

Recommended Cree® XSP HO Luminaire Lumen Maintenance Factors (LMF) ¹						
Ambient	Input Power Designator	Initial LMF	25K hr Projected ² LMF	50K hr Projected ² LMF	75K hr Calculated ³ LMF	100K hr Calculated ³ LMF
5°C	E	1.04	0.97	0.95	0.92	0.89
	H	1.04	0.99	0.97	0.94	0.91
10°C	E	1.03	0.97	0.95	0.92	0.89
	H	1.04	0.98	0.96	0.93	0.90
15°C	E	1.02	0.97	0.94	0.91	0.89
	H	1.04	0.98	0.96	0.93	0.90
20°C	E	1.01	0.96	0.93	0.90	0.87
	H	1.04	0.97	0.95	0.92	0.89
25°C	E	1.00	0.96	0.92	0.88	0.85
	H	1.04	0.97	0.95	0.92	0.89

¹ Lumen maintenance values at 25°C (77°F) are calculated per TM-21 based on LM-80 data and in-situ luminaire testing

² In accordance with IESNA TM-21-11, Projected Values represent interpolated value based on time durations that are within six times (6X) the IESNA LM-80-08 total test duration (in hours) for the device under testing ((DUT) i.e. the packaged LED chip)

³ In accordance with IESNA TM-21-11, Calculated Values represent time durations that exceed six times (6X) the IESNA LM-80-08 total test duration (in hours) for the device under testing ((DUT) i.e. the packaged LED chip)

Weight and Maximum Wind Area	
Weight	Lateral Surface Wind Exposed
10.5 kg	0.090m ²

XSP1™ High Output LED Street/Area Luminaire - Single Module

Control options

Field Adjustable Output - Input Power Designator E					
Setting	System Watts	Lumen Multipliers	Nominal flux (lm)		
			5700K	4000K	3000K
Q9	98	1.00	12336	12100	11483
Q8	94	0.97	11944	11715	11118
Q7	90	0.93	11473	11253	10679
Q6	85	0.90	11103	10890	10335
Q5	78	0.84	10363	10164	9646
Q4	71	0.79	9746	9559	9072
Q3	63	0.72	8882	8712	8268
Q2	56	0.66	8142	7986	7579
Q1	49	0.59	7278	7139	6775

Lumistep / Lineswitch - Input Power Designator H								
Setting	System Watts (High Mode)	Nominal flux (lm)			System Watts (Low Mode)	Nominal flux (lm)		
		5700K	4000K	3000K		5700K	4000K	3000K
L6* / G6	67	8541	8377	7950	34	4436	4351	4129
L5* / G5	59	7829	7679	7288	30	4066	3988	3785
L4* / G4	53	6999	6864	6515	27	3635	3565	3384
L3* / G3	45	5893	5780	5486	22	3061	3002	2849
L2* / G2	37	4783	4691	4452	22	3061	3002	2849
L1* / G1	29	3843	3770	3578	22	3061	3002	2849

* Dimming 6h or 8h

Virtual Midnight Y - Input Power Designator E								
Setting	System Watts (High Mode)	Nominal flux (lm)			System Watts (Low Mode)	Nominal flux (lm)		
		5700K	4000K	3000K		5700K	4000K	3000K
Y1	98	12336	12100	11483	74	10010	9818	9318
Y2	98	12336	12100	11483	49	7278	7139	6775
Y3	98	12336	12100	11483	25	3655	3585	3402
Y4	74	10010	9818	9318	49	7278	7139	6775
Y5	74	10010	9818	9318	25	3655	3585	3402
Y6	49	7278	7139	6775	25	3655	3585	3402

Virtual Midnight Z - Input Power Designator E								
Setting	System Watts (High Mode)	Nominal flux (lm)			System Watts (Low Mode)	Nominal flux (lm)		
		5700K	4000K	3000K		5700K	4000K	3000K
Z1	85	11103	10890	10335	68	9422	9241	8770
Z2	85	11103	10890	10335	54	7895	7744	7349
Z3	85	11103	10890	10335	34	4971	4876	4627
Z4	68	9422	9241	8770	54	7895	7744	7349
Z5	68	9422	9241	8770	34	4971	4876	4627
Z6	54	7895	7744	7349	34	4971	4876	4627

Dynadimmer - Input Power Designator H												
Setting	System Watts (High Mode)	Nominal flux (lm)			System Watts (Medium Mode)	Nominal flux (lm)			System Watts (Low Mode)	Nominal flux (lm)		
		5700K	4000K	3000K		5700K	4000K	3000K		5700K	4000K	3000K
DY6	67	8541	8377	7950	50	6429	6306	5984	34	4436	4351	4129
DY5	59	7829	7679	7288	45	5893	5780	5486	30	4066	3988	3785
DY4	53	6999	6864	6515	40	5268	5167	4904	27	3635	3565	3384
DY3	45	5893	5780	5489	34	4436	4351	4129	22	3061	3002	2849
DY2	37	4783	4691	4452	28	3683	3612	3428	22	3061	3002	2849
DY1	29	3843	3770	3578	22	3061	3002	2849	22	3061	3002	2849

XSP1™ High Output LED Street/Area Luminaire - Single Module

Photometry

All published luminaire photometric testing performed to IESNA LM-79-08 standards by a NVLAP certified laboratory. To obtain an IES file specific to your project consult: <http://www.cree-europe.com>.

2LG - Type II Long

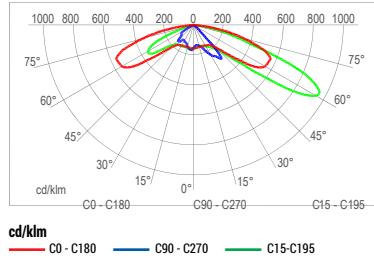

Test Report #: PL09478-001

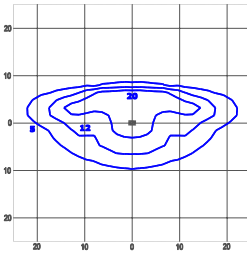

XSPD022LGE40K
Mounting Height: 8m

Lumen Output - 2LG (Type II Long)			
Input Power Designator	5700K	4000K	3000K
	Initial Delivered Lumens*	Initial Delivered Lumens*	Initial Delivered Lumens*
E	10950	10740	10193
H	7581	7435	7056

* Initial delivered lumens at 25°C (77°F). Actual production yield may vary between -4 and +10% of initial delivered lumens

275 - Type II Short 0.75 -

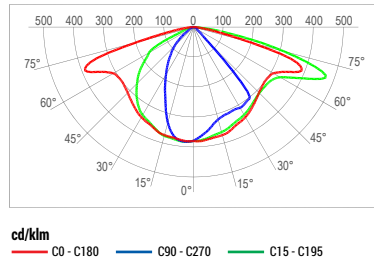

Test Report #: PL10065-001

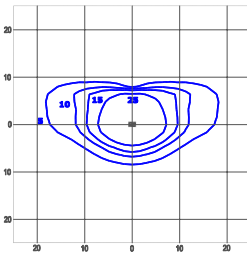

XSPD02275E40K
Mounting Height: 8m

Lumen Output - 275 (Type II Short 0.75)			
Input Power Designator	5700K	4000K	3000K
	Initial Delivered Lumens*	Initial Delivered Lumens*	Initial Delivered Lumens*
E	11129	10915	10359
H	7705	7557	7172

* Initial delivered lumens at 25°C (77°F). Actual production yield may vary between -4 and +10% of initial delivered lumens

210 - Type II Short 1.0

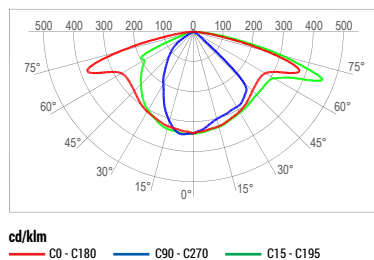

Test Report #: PL09097-001

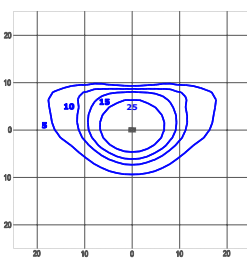

XSPD02210E40K
Mounting Height: 8m

Lumen Output - 210 (Type II Short 1.0)			
Input Power Designator	5700K	4000K	3000K
	Initial Delivered Lumens*	Initial Delivered Lumens*	Initial Delivered Lumens*
E	11473	11253	10679
H	7943	7791	7394

* Initial delivered lumens at 25°C (77°F). Actual production yield may vary between -4 and +10% of initial delivered lumens

2SH - Type II Short

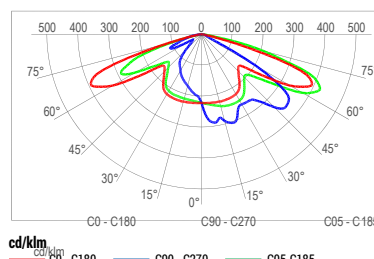

Test Report #: PL10065-002

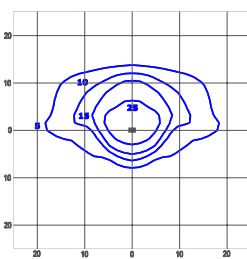

XSPD022SHE40K
Mounting Height: 8m

Lumen Output - 2SH (Type II Short)			
Input Power Designator	5700K	4000K	3000K
	Initial Delivered Lumens*	Initial Delivered Lumens*	Initial Delivered Lumens*
E	11072	10860	10307
H	7666	7519	7135

* Initial delivered lumens at 25°C (77°F). Actual production yield may vary between -4 and +10% of initial delivered lumens

XSP1™ High Output LED Street/Area Luminaire - Single Module

Photometry

All published luminaire photometric testing performed to IESNA LM-79-08 standards by a NVLAP certified laboratory. To obtain an IES file specific to your project consult: <http://www.cree-europe.com>.

3SH - Type III Short

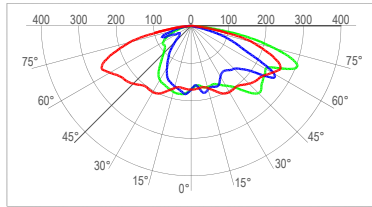

cd/klm
C0 - C180 C90 - C270 C45 - C225

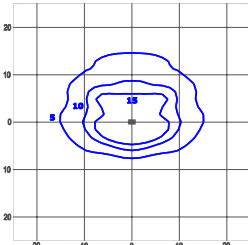

lux

Test Report #: PL09478-002

XSPD023SHE40K
Mounting Height: 8m

Lumen Output - 3SH (Type III Short)			
Input Power Designator	5700K	4000K	3000K
		Initial Delivered Lumens*	Initial Delivered Lumens*
E	10329	10131	9615
H	7151	7014	6657

* Initial delivered lumens at 25°C (77°F). Actual production yield may vary between -4 and +10% of initial delivered lumens

3ME - Type III Medium

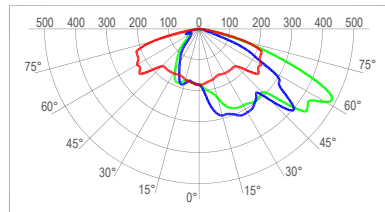

cd/klm
C0 - C180 C90 - C270 C45 - C225

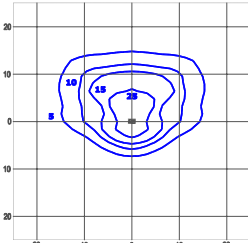

lux

Test Report #: PL10065-003

XSPD023MEE40K
Mounting Height: 8m

Lumen Output - 3ME (Type III Medium)			
Input Power Designator	5700K	4000K	3000K
		Initial Delivered Lumens*	Initial Delivered Lumens*
E	10838	10630	10088
H	7503	7359	6984

* Initial delivered lumens at 25°C (77°F). Actual production yield may vary between -4 and +10% of initial delivered lumens

4ME - Type IV Medium

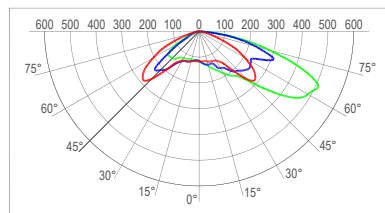

cd/klm
C0 - C180 C90 - C270 C45 - C225

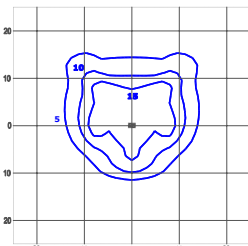

lux

Test Report #: PL10065-004

XSPD024MEE40K
Mounting Height: 8m

Lumen Output - 4ME (Type IV Medium)			
Input Power Designator	5700K	4000K	3000K
		Initial Delivered Lumens*	Initial Delivered Lumens*
E	11011	10800	10250
H	7623	7477	7096

* Initial delivered lumens at 25°C (77°F). Actual production yield may vary between -4 and +10% of initial delivered lumens